

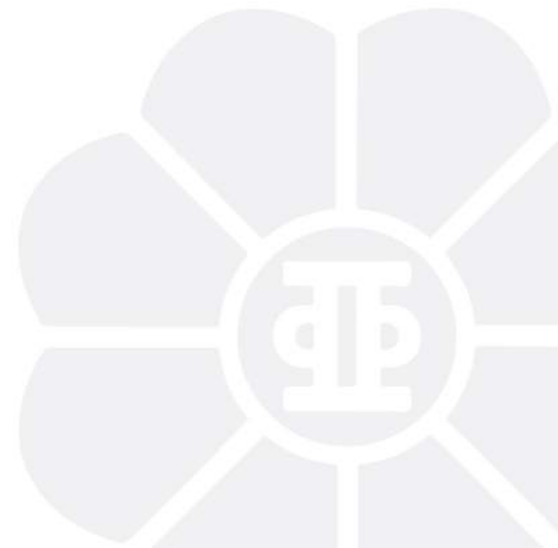

**LIGHTING
CATALOGUE**

2026-2027



Omni Electrical & Lighting

A brighter future

Bright ideas- reliably delivered

For nearly three decades, Omni Electrical & Lighting has been leading the industry with innovative ideas, cutting edge technology and manufacturing excellence. Choose Omni products for long-lasting quality, great value and complete peace of mind.

Everything you need under one roof

Choose from a full range of quality products including indoor lighting, outdoor lighting, electrical products and accessories. Available at leading electrical and lighting specialists throughout Australia.

• ELECTRICAL PRODUCTS

Quick connects, Surface sockets, Conduit fittings, Adaptable boxes, Mounting boxes, Weather proof outlets and more.

• ACCESSORIES

Saddles, Cable ties, Cable clips, Cable glands, Cable connectors and more.

• COMMERCIAL LIGHTING

High bays, Sensor high bays, Flood lights, Panels CCT/dimmable, Low profile lamps, E40 high bay bulbs, Corn lamps, T8 tubes and more.

• DOMESTIC LIGHTING

Down lights CCT, Down lights / gimbaled, Spike lights, Bunker lights, Security sensor lighting, Bulbs, GU10/dimmable, MR16, G412V and more.

A bright and sustainable future

Omni products are designed and manufactured with a minimal environmental footprint, and contribute to reduced emissions for the customers who install and use them.

A brighter future is here

When you choose Omni electrical and lighting products you get innovative technology, state-of-the-art manufacturing facilities and a focus on sustainability. Omni is one of the few companies in the business with R&D, manufacturing and sales all under one roof, ensuring reliable supply of our products when you need them.

There's many reasons why Omni is a great choice for your electrical and lighting needs.

Why switch to Omni LED?

With a huge investment in people and technology, our LED products are designed for maximum efficiency and functionality, while meeting the strictest environmental standards. Hundreds of product engineers work across 10 specialised testing laboratories with state-of-the-art technology to ensure all Omni products meet the highest quality standards at affordable prices.

Making great products, and a better world

We have a commitment to making the highest quality products that don't cost the earth. Continuous research and development helps us find better ways to make the products you and your customers use every day. We source sustainable raw materials, use low-impact manufacturing techniques and strive for efficiency in everything we do.

When you specify and use Omni electrical and lighting products you can be confident that they are as energy efficient as possible, meaning you can help protect the environment with lower energy usage, and also save money.

Omni. A risk-free choice

Get complete peace of mind when you purchase Omni's range of electrical and lighting products. When you specify and install our products, our industry-leading warranty of 5 years provides confidence that they will perform as intended and last for a long time.

Our Recall Insurance Policy provides the ultimate guarantee and is a completely risk-free choice. If one of our products fails we will not only replace the product, but also the cost of installing it.

Omni Electrical & Lighting are an Exclusive Supplier to MMEM Electrical and Go Electrical.

Make the switch to Omni Electrical & Lighting products today.



Omni Electrical & Lighting Pty Ltd

Head Office

17 Lacey St Croydon
Victoria 3136

Tel: 1300 333 001
Fax: 1300 333 002
Email: sales@omni-au.com
Website: www.omni-au.com

WA Sales Enquiry

Mob: 0415 591 059

NSW Sales Enquiry

Mob: 0415 591 059
Mob: 0491 704 352

ACT Sales Enquiry

Mob: 0491 704 352

QLD Sales Enquiry

Mob: 0415 591 059

Omni. A risk-free choice

Get complete peace of mind when you purchase Omni's range of electrical and lighting products. When you specify and install our products, our industry-leading warranty of 5 years provides confidence that they will perform as intended and last for a long time.

Our Recall Insurance Policy provides the ultimate guarantee and is a completely risk-free choice. If one of our products fails we will not only replace the product, but also the cost of installing it.

Omni Electrical and Lighting are an Exclusive Supplier to MMEM.

PRACTICAL ADVANTAGES OF USING OMNI LED

40W Incandescent Bulb		6W Omni LED A50 Bulb	
Light Output	470lm	Light Output	500lm
Consumption	40W	Consumption	6W
Life	1,000hrs	Life	20,000hrs

You can save up to **80% off** on your **BILLS** if you switch to OMNI LED Lights.



-  OMNI LED Bulbs conform to industry standards
-  OMNI LED Bulbs offer up to 90% ENERGY SAVINGS
-  OMNI LED Bulbs are long lasting
-  OMNI LED Bulbs are 100% recyclable
-  OMNI LED Bulbs don't emit UV rays and infrared



PARAMETERS	Incandescent	CFL	LED
On and Off Cycling	some	yes	no effect
Shock Resistance	fragile	fragile	durable
Heat Emissions	85 btu/hr	30 btu/hr	3 4 btu/hr
Failure Modes	abrupt	abrupt	dims over time
Color Rendering Index	2700k	2700K to 6500K	2700K to 6500K
Turns on Instantly	yes	no	yes

CONTENT

02	LED GLS Bulb Series	25/26	LED Lite PAR Bulb
04	LED Fancy Round Bulb Series	27	LED Wall Light & LED Spike Light
06	LED Sphere Bulb Series	28	LED Panel Light
07	LED R Bulb Series	29/30	LED Weatherproof Fixture
08	LED Lite 12V Bulb	31/32	LED Bunker Light
10	LED GU10 & MR16 GLOBE	33/34	High Bay Skye
12	LED Lite Filament Bulb Series	35/36	Sensor High Bay ZENITH 3 in 1
14	LED Lite Candle Bulb	37/38	High Bay TITAN 9 in 1
15-18	LED Lite Dimmable Bulb	39/40	LED FloodLight MARS
20	LED Lite PIN Bulb	41/42	LED Lite Flood Light
21	LED Lite G4 / G9 Bulb	43/44	LED Flood Light
22	LED Lite Capsule Bulb	45/46	LED Multi Functional Floodlight
23-24	LED Dimmable Downlight		



LED *Lite* GLS Bulb Series

FEATURES

- Up to 85% Energy Savings
- 300° Beam Angle
- Concealed aluminum heat sink enveloped in heat absorbing compound
- Enclosed in polycarbonate plastic that is impact and heat resistant
- Lights up instantly compared to CFL
- Not affected by frequency of ON and OFF
- High colour rendering index
- Mercury Free
- SMD LED Technology
- Less heat emission
- SAA / CE and RoHS Compliant
- 20,000 Hours of operations



LED A50 Bulb - 6W

MODEL	CCT	LUMENS	CRI
LLA50E27-6W-DL	5000K	500lm	>80
LLA50E27-6W-WW	3000K	450lm	>80
LLA50B22-6W-DL	5000K	500lm	>80
LLA50B22-6W-WW	3000K	450lm	>80



LED A55 Bulb - 7W

MODEL	CCT	LUMENS	CRI
LLA55E27-7W-DL	5000K	600lm	>80
LLA55E27-7W-WW	3000K	580lm	>80
LLA55B22-7W-DL	5000K	600lm	>80
LLA55B22-7W-WW	3000K	580lm	>80



LED A60 Bulb - 9W

MODEL	CCT	LUMENS	CRI
LLA60E27-9W-DL	5000K	800lm	>80
LLA60E27-9W-WW	3000K	750lm	>80
LLA60B22-9W-DL	5000K	800lm	>80
LLA60B22-9W-WW	3000K	750lm	>80



LED A65 Bulb - 12W

MODEL	CCT	LUMENS	CRI
LLA65E27-12W-DL	5000K	1100lm	>80
LLA65E27-12W-WW	3000K	1000lm	>80
LLA65B22-12W-DL	5000K	1100lm	>80
LLA65B22-12W-WW	3000K	1000lm	>80



LED A72 Bulb - 15W

MODEL	CCT	LUMENS	CRI
LLA72E27-15W-DL	5000K	1300lm	>80
LLA72B22-15W-DL	5000K	1300lm	>80

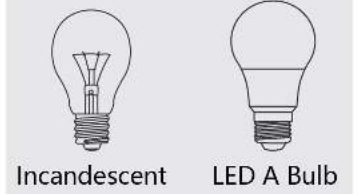

40W	>	6W
60W	>	7W
75W	>	9W
80W	>	12W
100W	>	15W



PACKING: 48pcs/ctn



Fancy Round Bulb Series

FEATURES

- Up to 85% Energy Savings.
- 220°/300° Beam Angle.
- Concealed aluminum heat sink enveloped in heat absorbing compound.
- Enclosed in polycarbonate plastic that is impact and heat resistant.
- Lights up instantly compared to CFL.
- Not affected by frequency of ON and OFF.
- High colour rendering index.
- Mercury Free.
- SMD LED Technology.
- Less heat emission.
- SAA / CE and RoHS Compliant.
- 20,000 Hours of operations.



LED G45 Bulb - 4W

MODEL	CCT	LUMENS	CRI
LLG45E14-4W-DL	5000K	340lm	>80
LLG45E14-4W-WW	3000K	325lm	>80
LLG45E27-4W-DL	5000K	340lm	>80
LLG45E27-4W-WW	3000K	325lm	>80

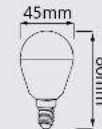

LLG45B15-4W-DL	5000K	340lm	>80
LLG45B15-4W-WW	3000K	325lm	>80
LLG45B22-4W-DL	5000K	340lm	>80
LLG45B22-4W-WW	3000K	325lm	>80



LED G45 Prestige Bulb - 4W

MODEL	CCT	LUMENS	CRI
LCG45E14-4W-DL	5000K	350lm	>80
LCG45E14-4W-WW	3000K	325lm	>80
LCG45E27-4W-DL	5000K	350lm	>80
LCG45E27-4W-WW	3000K	325lm	>80



LCG45B15-4W-DL	5000K	350lm	>80
LCG45B15-4W-WW	3000K	352lm	>80
LCG45B22-4W-DL	5000K	350lm	>80
LCG45B22-4W-WW	3000K	325lm	>80





Incandescent

30W



LED

4W

➔

 240V

 20,000 Hours

 UP TO 85% ENERGY SAVINGS

 Non-Dimmable

 Beam Angle 300° / 220°



 CE

 RoHS Compliant

 FC

 SAFE EASY TO USE

 NO UV/IR



PACKING: 48pcs/ctn



Sphere Bulb Series

FEATURES

- Up to 85% Energy Savings.
- Concealed aluminum heat sink enveloped in heat absorbing compound.
- Enclosed in polycarbonate plastic that is impact and heat resistant.
- Lights up instantly compared to CFL.
- Not affected by frequency of ON and OFF.
- High colour rendering index.
- Mercury Free.
- SMD LED Technology.
- Less heat emission.
- SAA / CE and RoHS Compliant.
- 20,000 Hours of operations.



LED G70 Sphere Bulb - 8W

MODEL	CCT	LUMENS	CRI
LLG70E27-8W-WW	3000K	600lm	>80
LLG70B22-8W-DL	5000K	650lm	>80
LLG70B22-8W-WW	3000K	600lm	>80



Incandescent

LED

70W

100W

120W

➤

8W

12W

16W



LED G95 Sphere Bulb - 12W

MODEL	CCT	LUMENS	CRI
LLG95E27-12W-DL	5000K	1050lm	>80
LLG95E27-12W-WW	3000K	1000lm	>80
LLG95B22-12W-DL	5000K	1050lm	>80
LLG95B22-12W-WW	3000K	1000lm	>80



240V

20,000
Hours

UP TO
85%
ENERGY
SAVINGS

Non-Dimmable

Beam Angle
300°









SAFE
EASY TO USE

NO
UV/IR





LED G120 Sphere Bulb - 16W

MODEL	CCT	LUMENS	CRI
LLG120E27-16W-DL	5000K	1200lm	>80
LLG120E27-16W-WW	3000K	1150lm	>80
LLG120B22-16W-DL	5000K	1200lm	>80
LLG120B22-16W-WW	3000K	1150lm	>80



PACKING:
G70 30pcs/ctn
G95 24pcs/ctn
G120 12pcs/ctn



LED R50 Bulb - 5W

MODEL	CCT	LUMENS	CRI
LPR50E14-5W-DL	5000K	370lm	>80

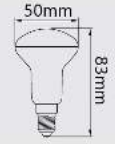

Incandescent

35W
60W
80W

LED

5W
8W
10W

240V

20,000
Hours

UP TO
85%
ENERGY
SAVINGS

Non-Dimmable

Beam Angle
100°

RoHS
Compliant

SAFE
EASY TO USE

NO
UV/IR

PACKING: 48pcs/ctn



LED R63 Bulb - 8W

MODEL	CCT	LUMENS	CRI
LPR63E27-8W-DL	5000K	700lm	>80
LPR63E27-8W-WW	3000K	600lm	>80
LPR63B22-8W-DL	5000K	700lm	>80
LPR63B22-8W-WW	3000K	600lm	>80

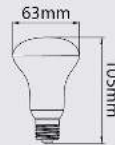

LED R80 Bulb - 10W

MODEL	CCT	LUMENS	CRI
LPR80E27-10W-DL	5000K	900lm	>80
LPR80E27-10W-WW	3000K	800lm	>80
LPR63B22-10W-DL	5000K	900lm	>80
LPR63B22-10W-WW	3000K	800lm	>80

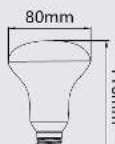

LED
Lite



LED G45 Bulb 12V - 4W			
MODEL	CCT	LUMENS	CRI
LCG45E27-4W-12V-VW	3000K	320lm	>80



Incandescent



LED 12V

30W
60W

>
>

4W
8W



LED A60 Bulb 12V - 8W			
MODEL	CCT	LUMENS	CRI
LLA60E27-8W-12V-DL	5000K	700lm	>80
LLA60E27-8W-12V-VW	3000K	600lm	>80

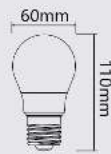

 240V	 20,000 Hours	 UP TO 85% ENERGY SAVINGS
 Non-Dimmable	 Beam Angle 300°	
		
 SAFE EASY TO USE	 NO UV/IR	

PACKING: 48pcs/ctn



LED GU10/MR16 GLOBE

FEATURES

- 90% energy savings when compared to halogen bulbs.
- Safe to use with GU10 twist to lock base.
- UV and IR free.
- Mercury free.
- SMD LED Technology.
- Less heat emission.
- SAA / CE and RoHS Compliant.
- 20,000 hours of operations.

Non-Dimmable



LED GU10 Globe - 5W			
MODEL	CCT	LUMENS	CRI
LFGU10-5W-DL	6500K	400lm	>80
LFGU10-5W-WW	3000K	380lm	>80

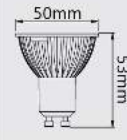

LED GU10 Globe - 8W			
MODEL	CCT	LUMENS	CRI
LFGU10-8W-DL	5000K	650lm	>80
LFGU10-8W-WW	3000K	600lm	>80



LED MR16 Globe 12V - 8W			
MODEL	CCT	LUMENS	CRI
LFMR16-8W-DL	5000K	650lm	>80
LFMR16-8W-WW	3000K	600lm	>80



Dimmable



LED GU10 Globe - 8W			
MODEL	CCT	LUMENS	CRI
LFGU10D-8W-DL	5000K	650lm	>80
LFGU10D-8W-WW	3000K	600lm	>80

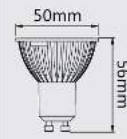

LED GU10 Globe - 12W			
MODEL	CCT	LUMENS	CRI
LFGU10D-12W-DL	5000K	1000lm	>80
LFGU10D-12W-WW	3000K	950lm	>80

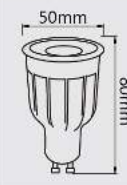

LED MR16 Globe 12V - 8W			
MODEL	CCT	LUMENS	CRI
LFMR16D-8W-DL	5000K	650lm	>80
LFMR16D-8W-WW	3000K	600lm	>80



Halogen



LED

35W > 5W
50W > 8W
70W > 12W

240V	12V	20,000 Hours
Non-Dimmable	Dimmable	UP TO 85% ENERGY SAVINGS
5W 120°	8W 60°	8W 60°
RoHS Compliant	CE	RoHS Compliant
FC	SAFE EASY TO USE	NO UV/IR

PACKING: 48pcs/ctn



LED
Lite

Filament Bulb

FEATURES

- Retro-style LED bulb, classical model.
- Long life span, low heat, not hot when touch.
- Traditional filament design, use 3D light emitting filament, wide beam angle, high efficacy.
- Adopt special light transmission glass cover, high transmittance rate, no shadow and dark space.



LED Candle - 4W			
MODEL	CCT	LUMENS	CRI
LFCC35E14D-4W-WW	2700K	450lm	>80
LFCC35E14D-4W-CW	4000K	500lm	>80

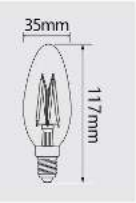

LED G45 Bulb - 4W			
MODEL	CCT	LUMENS	CRI
LFCG45E14D-4W-WW	2700K	450lm	>80
LFCG45E27D-4W-WW	2700K	450lm	>80

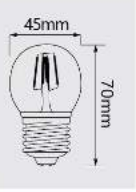

LED GLS A60 - 6W			
MODEL	CCT	LUMENS	CRI
LFCA60E27D-6W-WW	2700K	580lm	>80

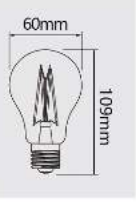

LED Sphere G95 - 6W			
MODEL	CCT	LUMENS	CRI
LFCG95E27D-6W-WW	2700K	580lm	>80



LED Sphere G125 - 6W			
MODEL	CCT	LUMENS	CRI
LFCG125E27D-6W-WW	2700K	580lm	>80

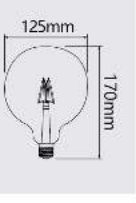

LED Pear P64 - 6W			
MODEL	CCT	LUMENS	CRI
LFPC64E27D-6W-WW	2700K	580lm	>80

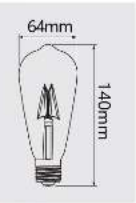



Incandescent



LED A Bulb

30W > **4W**
40W > **6W**



220-240V~
50/60Hz



20,000
Hours



UP TO
85%
ENERGY
SAVINGS



Dimmable



Beam Angle
320°



RoHS
Compliant



CE



FC



SAFE
EASY TO USE



NO
UV/IR



PACKING:
Candle / G45 / A60: 48pcs/ctn
G95: 24pcs/ctn
P64: 48pcs/ctn
G125: 12pcs/ctn



LED Lite Candle Bulbs



FEATURES

- Up to 90% Energy Savings.
- 220 Beam Angle on Frosted and 220° Beam Angle on Clear cover.
- Concealed aluminum heat sink enveloped in heat absorbing compound.
- Enclosed in polycarbonate plastic that is impact and heat resistant.
- Lights up instantly compared to CFLs.
- Not affected by frequency of ON and OFF.
- High colour rendering index.
- Mercury Free.
- SMD LED Technology.
- Less heat emission.
- SAA / CE and RoHS Compliant.
- 20,000 Hours of operations.



LED Candle Bulb - 4W			
MODEL	CCT	LUMENS	CRI
LCC35E27-4W-DL	5000K	300lm	>80
LCC35E27-4W-WW	3000K	270lm	>80
LCC35B15-4W-DL	5000K	300lm	>80
LCC35B15-4W-WW	3000K	270lm	>80
LCC35B22-4W-DL	5000K	300lm	>80
LCC35B22-4W-WW	3000K	270lm	>80





Incandescent

25W



LED

4W

➔



240V



20,000
Hours

UP TO
85%
ENERGY
SAVINGS



Non-Dimmable



Beam Angle
220°







RoHS
Compliant





SAFE
EASY TO USE



NO
UV/IR



PACKING: 48pcs/ctn



LED Candle Bulb - 4W			
MODEL	CCT	LUMENS	CRI
LCF35E27-4W-DL	5000K	300lm	>80
LCF35E27-4W-WW	3000K	270lm	>80
LCF35E14-4W-DL	5000K	300lm	>80
LCF35E14-4W-WW	3000K	270lm	>80
LCF35B15-4W-DL	5000K	300lm	>80
LCF35B15-4W-WW	3000K	270lm	>80
LCF35B22-4W-DL	5000K	300lm	>80
LCF35B22-4W-WW	3000K	270lm	>80

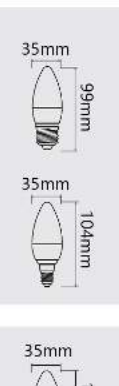



LED
Lite

Dimmable Bulb



LED A55 Bulb Dimmable - 7W

MODEL	CCT	LUMENS	CRI
LLA55E27D-7W-DL	5000K	600lm	>80
LLA55E27D-7W-WW	3000K	580lm	>80
LLA55B22D-7W-WW	3000K	580lm	>80



Incandescent



LED

60W > **7W**
75W > **9W**
100W > **12W**



LED A60 Bulb Dimmable - 9W

MODEL	CCT	LUMENS	CRI
LLA60E27D-9W-DL	5000K	800lm	>80
LLA60B22D-9W-DL	5000K	800lm	>80
LLA60B22D-9W-WW	3000K	750lm	>80



 240V	 20,000 Hours	 UP TO 85% ENERGY SAVINGS
 Dimmable	 Beam Angle 300°	
 CE	 RoHS Compliant	 FCC
 SAFE EASY TO USE	 NO UV/IR	



LED A65 Bulb Dimmable - 12W

MODEL	CCT	LUMENS	CRI
LLA65B22D-12W-DL	5000K	1100lm	>80



PACKING: 48pcs/ctn



LED G45 Bulb Dimmable - 6W			
MODEL	CCT	LUMENS	CRI
LLG45E14D-6W-DL	5000K	420lm	>80
LLG45E14D-6W-WW	3000K	400lm	>80
LLG45E27D-6W-DL	5000K	420lm	>80
LLG45E27D-6W-WW	3000K	400lm	>80
LLG45B15D-6W-DL	5000K	420lm	>80
LLG45B15D-6W-WW	3000K	400lm	>80
LLG45B22D-6W-DL	5000K	420lm	>80



Incandescent

40W
100W
120W

LED

6W
12W
16W

240V

20,000
Hours

UP TO
85%
ENERGY
SAVINGS

Dimmable

Beam Angle
300°

RoHS
Compliant

CE

FC

SAFE
EASY TO USE

NO
UV/IR

PACKING:

G45 48pcs/ctn
G95 24pcs/ctn
G120 12pcs/ctn



LED G95 Bulb Dimmable - 12W			
MODEL	CCT	LUMENS	CRI
LLG95E27D-12W-DL	5000K	1050lm	>80
LLG95B22D-12W-DL	5000K	1050lm	>80
LLG95B22D-12W-WW	3000K	1000lm	>80



LED G120 Bulb Dimmable - 16W			
MODEL	CCT	LUMENS	CRI
LLG120B22D-12W-DL	5000K	1200lm	>80





LED Candle Bulb Dimmable - 6W			
MODEL	CCT	LUMENS	CRI
LCC35E27D-6W-DL	5000K	410lm	>80
LCC35E27D-6W-VVV	3000K	390lm	>80
LCC35E14D-6W-DL	5000K	410lm	>80
LCC35E14D-6W-VVV	3000K	390lm	>80
LCC35B15D-4W-DL	5000K	410lm	>80
LCC35B15D-4W-VVV	3000K	390lm	>80
LCC35B22D-4W-DL	5000K	410lm	>80
LCC35B22D-4W-VVV	3000K	390lm	>80



LED Candle Bulb Dimmable - 6W			
MODEL	CCT	LUMENS	CRI
LCF35E14D-6W-DL	5000K	410lm	>80
LCF35B15D-4W-DL	5000K	410lm	>80
LCF35B15D-4W-VVV	3000K	390lm	>80
LCF35B22D-4W-DL	5000K	410lm	>80
LCF35B22D-4W-VVV	3000K	390lm	>80





Incandescent

40W



LED

6W

➤



240V



20,000
Hours



UP TO
85%
ENERGY
SAVINGS



Dimmable



Beam Angle
220°



RoHS
Compliant



CE



FC



SAFE
EASY TO USE



NO
UV/IR



PACKING: 48pcs/ctn



LED
Lite

PIN Bulb

FEATURES

- 50% energy savings when compared to cfl pinlights.
- 360° beam angle.
- Mercury free.
- SMD LED Technology.
- Less heat emission.
- SAA / CE and RoHS Compliant.
- 20,000 hours of operations.



LED PIN Bulb - 7W			
MODEL	CCT	LUMENS	CRI
LPLG24D-7W-DL	5000K	600lm	>80
LPLG24D-7W-WW	3000K	550lm	>80
LPLE27-7W-DL	5000K	600lm	>80
LPLE27-7W-WW	3000K	550lm	>80
LPLE14-7W-DL	5000K	600lm	>80
LPLB22-7W-DL	5000K	600lm	>80
LPLB22-7W-WW	3000K	550lm	>80
LPLB15-7W-DL	5000K	600lm	>80
LPLB15-7W-WW	3000K	550lm	>80





Incandescent

11W
14W
18W



LED A Bulb

7W
9W
12W



LED PIN Bulb - 9W			
MODEL	CCT	LUMENS	CRI
LPLG24D-9W-DL	5000K	840lm	>80
LPLG24D-9W-WW	3000K	810lm	>80
LPLE27-9W-WW	3000K	810lm	>80
LPLB22-9W-DL	5000K	840lm	>80
LPLB22-9W-WW	3000K	810lm	>80



LED PIN Bulb - 12W			
MODEL	CCT	LUMENS	CRI
LPLG24D-12W-DL	5000K	1100lm	>80
LPLG24D-12W-WW	3000K	1000lm	>80
LPLE27-12W-DL	5000K	1100lm	>80
LPLE27-12W-WW	3000K	1000lm	>80
LPLB22-12W-DL	5000K	1100lm	>80
LPLB22-12W-WW	3000K	1000lm	>80





220-240V~
50/60Hz



20,000
Hours



UP TO
85%
ENERGY
SAVINGS



Non-Dimmable



Beam Angle
360°







RoHS
Compliant





SAFE
EASY TO USE



NO
UV/IR



PACKING: 48pcs/ctn



LED G4 Bulb - 1.5W			
MODEL	CCT	LUMENS	CRI
LCG4-1.5W-DL	5000K	110lm	>80
LCG4-1.5W-WW	3000K	100lm	>80

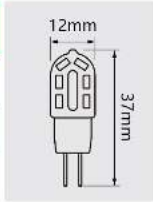

LED G9 Bulb - 2.5W			
MODEL	CCT	LUMENS	CRI
LCG9-2.5W-DL	5000K	250lm	>80
LCG9-2.5W-WW	3000K	220lm	>80

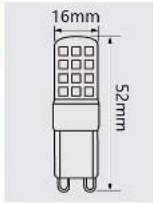

G4 12V	G9 240V	20,000 Hours
Non-Dimmable	Beam Angle 300°	RoHS
CE	RoHS Compliant	FCC
SAFE EASY TO USE	NO UV/IR	UP TO 85% ENERGY SAVINGS
PACKING: 144pcs/ctn		



LED *Lite* Capsule Bulb

FEATURES

- 360° beam angle.
- Up to 85% energy savings.
- Higher light output at 100 lumen per watts.
- Stylish and elegant design.
- SMD LED technology.
- Less heat emission.
- FCC, CE and RoHS Compliant.
- 40,000 hours of operations.
- Non-dimmable.
- Molded plastic lamp casing.
- Easy to install.

LED Capsule Bulb - 20W			
MODEL	CCT	LUMENS	CRI
LM65E27-20W-DL	5000K	2100lm	>80



 CFL 40W	 LED 20W	
 240V	 20,000 Hours	 UP TO 85% ENERGY SAVINGS
 Non-Dimmable	 Beam Angle 360°	
		
 SAFE EASY TO USE	 NO UV/IR	
PACKING: 24pcs/ctn		

LED Star Eco



240VAC	10W	120° SUPER WIDE ANGLE	Dimmable
CRI >80	Flex&Plug	Cutout Size \varnothing 90mm	

Features and Benefits

- Integrated design, easy installation.
- Poly carbonate housing with aluminum heat-sink.
- Triac dimmable technology.
- CCT 3-in-1, DL/CW/WW.
- With 1.2m cable and plug.
- SAA/IC-4 certified.

Caution

- Operating temperature should range between -20 °C and 40 °C
- Never disassemble or modify the fixture

Warning

Warranty will be voided if the power lead is removed

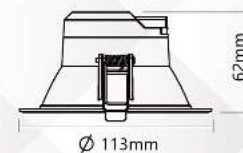

LED Down Light STAR TRIO ECO - 9W



MODEL	CCT	LUMENS	CRI	BA	VOLTAGE	PF	DIM	CUTOUT	DIMENSION
LSDD-10W-CCT/WH	Switched 3000/4000/5000K	1000 lm	Ra80	120°	220~240Vac	0.9	Yes	\varnothing 90mm	D113 H62

LED
LaVille



Features and Benefits

- Patent design with 360°adjustable direction without gap for dust proof .
- High efficient COB LEDs with adjustable CCT 3000/4000/5000K.
- Aluminium housing and external driver are good for heat-sink.
- Integrated multi-switch for easy-adjustable CCT 3-in-1, saving stock.
- External driver with improved block is easy for connection in series.
- Triac dimmable tech. make it easier match with popular dimmer.
- Remix housing and adjustable module in white and black color are available.
- With 1.2m cable and plug.
- SAA / IC-4 certificate approved.

 8W	 240V	 60°	 40,000Hours	 IP Rating IP24
 Dimmable	 Flex & Plug	 Ø 90mm	 IC Rating IC-4	



LED LaVille (White Housing) - 8W

MODEL	HOUSING	CCT	LUMENS	CRI	PACKING
LLDT-8W-CCT/WH	White	3000/4000/5000K	650lm	>80	48pcs/ctn





 *Lite*
PAR Bulb

FEATURES

- 85% energy savings.
- Weatherproof IP65 rating.
- Lightweight.
- Stays cool even after long period of use.
- Higher light intensity of up to 15 meters.
- Polycarbonate enclosure.
- Mercury free.
- SMD LED Technology.
- Less heat emission.
- SAA/ CE and RoHS Compliant.
- 20,000 hours of operations.



LED Par30 Lamps - 10W			
MODEL	CCT	LUMENS	CRI
LPR30E27-10W/B	BLUE	-	>80
LPR30E27-10W/R	RED	-	>80
LPR30E27-10W/D	6500K	750lm	>80
LPR30E27-10W/W	3000K	700lm	>80



LED Par38 Lamps - 15W			
MODEL	CCT	LUMENS	CRI
LPR38E27-15W/G	GREEN	-	>80
LPR38E27-15W/D	6500K	1100lm	>80



Incandescent



LED A Bulb

75W
120W

>
>

10W
15W

 220-240V~ 50/60Hz	 20,000 Hours	 UP TO 85% ENERGY SAVINGS
 Non- Dimmable	 Beam Angle 30°	
	 RoHS Compliant	
 SAFE EASY TO USE	 NO UV/IR	

PACKING:
10W 24pcs/ctn
15W 12pcs/ctn



LED Wall Light - 10W

MODEL	CCT	LUMENS	CRI
LWA-10W-CW	4000K	850lm	>80



220-240V~50/60Hz	IP65	IK06
Non-Dimmable	Adjustable beam angle	
PF 0.9		
CE	RoHS Compliant	FC
SAFE EASY TO USE	NO UV/IR	

PACKING: 24pcs/ctn



LED Spike Light - 6W

MODEL	CCT	LUMENS	CRI
LPK-6W-WW	3000K	480lm	>80

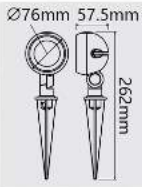

220-240V~50/60Hz	IP65	IK06
Non-Dimmable	60°	
PF 1		
CE	RoHS Compliant	FC
SAFE EASY TO USE	NO UV/IR	

PACKING: 24pcs/ctn



New Flicker free CCT Back-Lit LED Panel

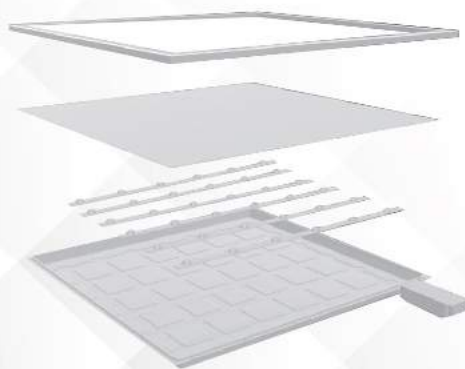

Features and Benefits

- Commercial application of all types.
- Flicker free design for Schools, Hospitals, Security camera's.
- Back-lit design. Emitting light across the entire panel surface area eliminating dark-spot.
- Metal frame and back plate. Powder coated, long lasting and light weight.
- CCT Colour Changing Temperature. Inline switch.
- EMC Electromagnetic Compatibility passed.
- Dimmable capabilities - Seperate driver available.
- Isolated driver.
- Rated life span 25,000 hrs. Maintenance free.



MODEL	WATT	SWITCHED CCT	LUMENS	CRI	DRIVER	VOLTAGE	PF	FLICKER FREE	DIMENSION		
									L	W	H
LBP312-36W-CCT	36W	3000/4000/5700K	3600lm	80	Lsolated	180-277Vac	0.9	Yes	1195	295	25
LBP360-16W-CCT	16W	3000/4000/5700K	1600lm	80	Lsolated	180-277Vac	0.9	Yes	595	295	25
LBDP-36W			LED dimmable driver for back-lit panel 36W								
LBDP-16W			LED dimmable driver for back-lit panel 16W								

*Lighter
Thinner
Brighter*



Weatherproof Fixture

Replace your traditional louvers with LED Weatherproof Fixture for uniform light output and better coverage.

FEATURES

- Integrated slim design.
- Uniform light output for better area coverage.
- Built-in high efficient SMD LED chips.
- Built-in aluminium heat-sink.
- Indoor and outdoor applications.
- Surface mount or suspended application.
- Easy plug and play installation.
- Up to 30,000hrs.
- SAA/CE/RoHS/EMC approved.

LED Weatherproof Fixture - 18W

MODEL	CCT	LUMENS	PF	CRI
LLW-18W-DL	5000K	1600lm	>0.9	>80
LLW-18W-CW	4000K	1500lm	>0.9	>80



* Installation accessories included.

LED Weatherproof Fixture - 36W

MODEL	CCT	LUMENS	PF	CRI
LLW-36W-CW	4000K	3100lm	>0.9	>80



* Installation accessories included.

LED Weatherproof Fixture - 45W

MODEL	CCT	LUMENS	PF	CRI
LLW-45W-DL	5000K	4000lm	>0.9	>80
LLW-45W-CW	4000K	3900lm	>0.9	>80

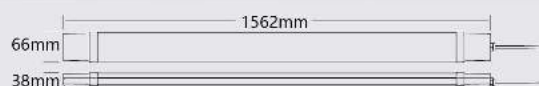

* Installation accessories included.



Installation accessories

PACKING: 20pcs/ctn



Make the switch to Omni LED bunker light for outdoor illumination.



Bunker Light

FEATURES

- Non corrosive plastic casing & polycarbonate design.
- Impact resistant IP65.
- Can be ceiling or wall mounted.
- Opaque diffuser for soft light effect without glare.
- Mercury free.
- SMD LED Technology.
- Less heat emission.
- SAA / CE and RoHS Compliant.
- 20,000 hours of operations.





LED Bunker Light Plastic Casing - 10W



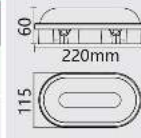



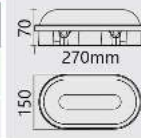

MODEL	CCT	LUMENS	CRI
LWOL-10WDL	5000K	850lm	>80
LWOL-10WW	3000K	800lm	>80



LED Bunker Light Plastic Casing - 20W

MODEL	CCT	LUMENS	CRI
LWOL-20WDL	5000K	1700lm	>80
LWOL-20WW	3000K	1600lm	>80



 240V	 20,000 Hours	IP65
 Non-Dimmable	 Beam Angle 270°	
CE	 RoHS Compliant	FC
 SAFE EASY TO USE	 NO UV/IR	UP TO 85% ENERGY SAVINGS
		

PACKING: 10pcs/ctn



LED Bunker Light Plastic Casing - 10W

MODEL	CCT	LUMENS	CRI
LWCL-10WDL	5000K	850lm	>80
LWCL-10WW	3000K	800lm	>80

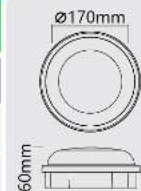

LED Bunker Light Plastic Casing - 20W

MODEL	CCT	LUMENS	CRI
LWCL-20WW	3000K	1600lm	>80

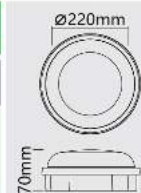

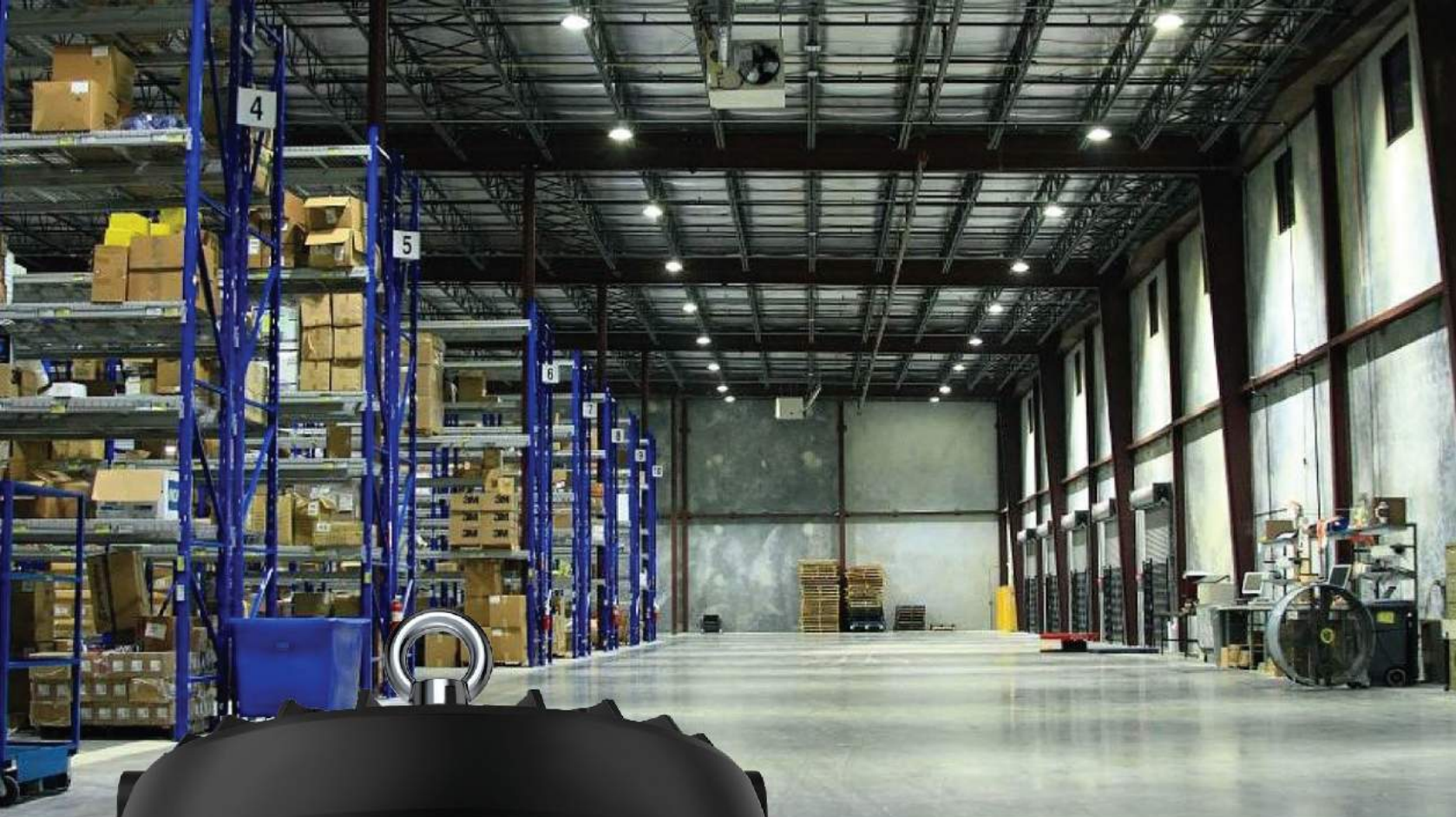

CREE SMD2835	150 lm/w	CRI 80	120° Beam Angle	LM80	TM21
Isolated driver	 90-305Vac	4KV surge protection	3-in-1 dimming 1-10V, PWM, Resistance		
		TGIC painting	DIY lens	IP65	IK08
IES available	50,000 hrs	5Year Warranty	CE	 RoHS	

HIGH BAY SKYE

FEATURES AND BENEFITS

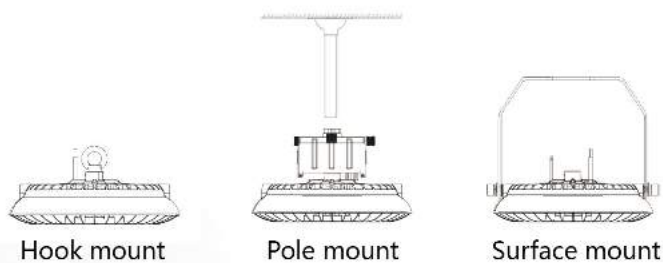

- Lighter, slimmer, smaller and brighter.
- CREE SMD2835 LEDs are providing higher efficiency, up to 150lm/w.
- Built-in quality/stable driver providing higher efficiency up to 96%.
- Isolated 3-in-1 dimming option, 1-10v, PMW, resistance.
- Patent housing. Lighter, slimmer and smaller in size.
- TGIC paint material. Suitable for tough application.
- Optional reflector 60degree.
- Sensor version available.
- 5-year warranty "RIP" Recall Insurance Policy exclusive to your business.

INSTALLATION



REFLECTOR



MODEL	WATT	LEDs	LUMENS	CCT	CRI	Beam Angle	Voltage	PF	N.W./pc	Surge Protection	Dimension D	Dimension H
LSKD-150W-DL	150W		22500lm	5000K	80	60°/70° 90°/120°	90~305VAC	0.95	2.65kg	4KV	275	152
LSKD-200W-DL	200W		30000lm	5000K	80	60°/70° 90°/120°	90~305VAC	0.95	2.65kg	4KV	275	152

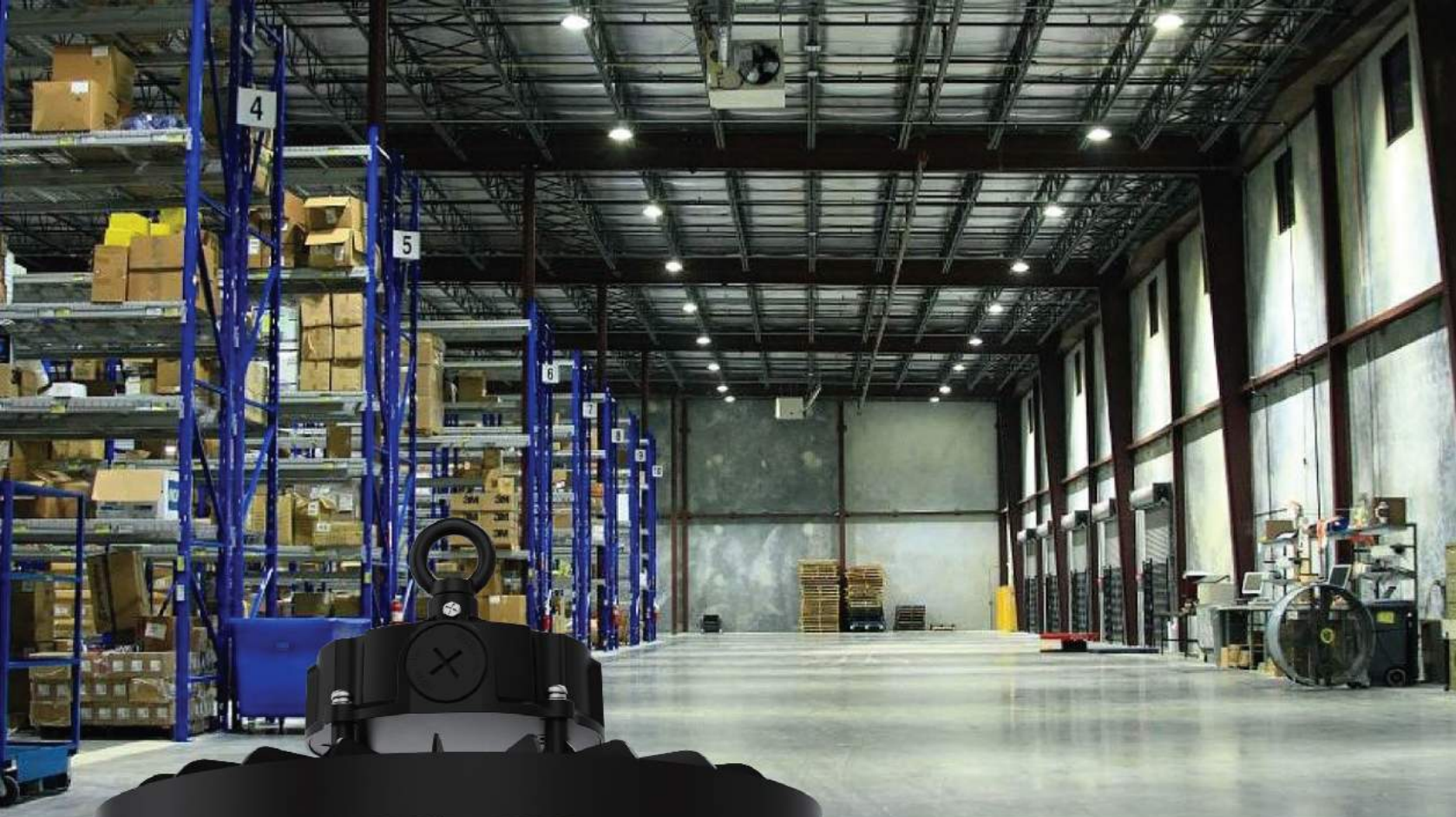

- | | | | | | |
|--------------------------|-----------------------------|---------------------------|------------------------------|------------------|--------------------------------|
| LITEON
SMD5050 | up to
200
lm/w | CRI
70 | 110°
Beam Angle | LM80 | TM21 |
| | | MOSO
Driver | Operating temp
-20°C~50°C | 90-305Vac | 6KV
surge protection |
| | | | TGIC
painting | IP65 | IK08 |
| IES
available | 50,000
hrs | 5 Year
Warranty | CE | RoHS | |

SENSOR HIGH BAY **ZENITH 3 in 1**

FEATURES AND BENEFITS

- Cutting-edge innovation: Slimmer, Lighter and Brighter Design.
- SMD5050 LEDs with life span 108,000hrs@L70B50, SuperLUX up to 200lm/w.
- Driver with 90~305Vac, PF \geq 0.95, 6kV surge protection, SCP/OVP/OTP protection.
- 3-in-1 Power selectable by dip-switch, less SKU and lower shipping cost.
- Optional PC dot lens with beam angle 60°/90°/110°, easier replacement.
- Improved anti-glare design of Dot lens with UGR \leq 22@60°/90°.
- IP65+IK08 protection.
- Pre-wired with regular power plug. 1m lead, and mounting hook.
- TGIC tough coating application.
- Available with Surface Mounted installation, default with Ring.
- Available with reflector.
- Complied by IEC60598/CE/RoHS/SAA.
- Rated life span 50,000hrs@L70B50@25C.
- 5-year warranty "RIP" Recall Insurance Policy.

INSTALLATION

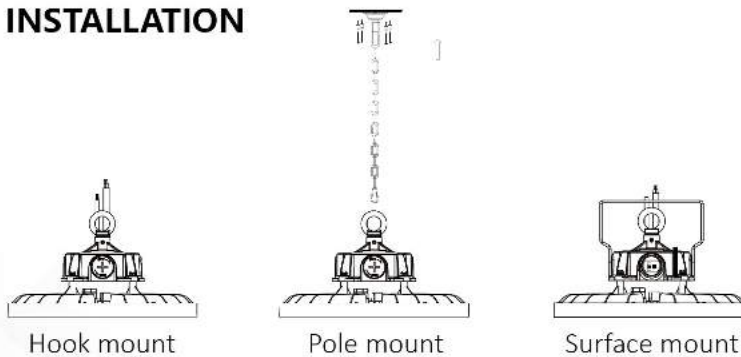

Power off before installation

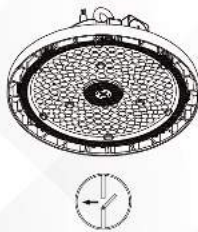

Remove the sensor base cap

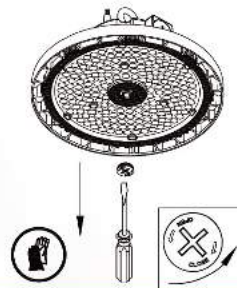

Install sensor by icon indication

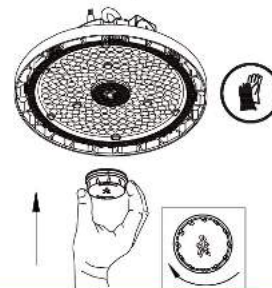

Finished

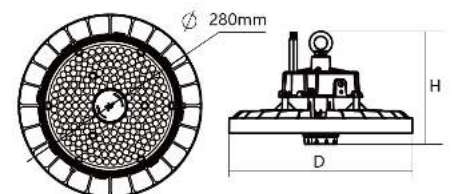
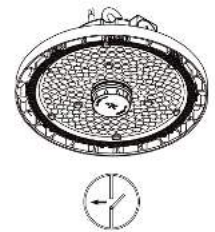

MODEL	Power Selectable	LEDs	LUMENS	CCT	CRI	Beam Angle	Voltage	PF	NW/pc	Surge Protection	Dimension D	Dimension H
LSZD-200WPS-DL	200W 150W 100W	LITEON [®] SMD5050	40000lm 30000lm 20000lm	5000K	70	110°	90~305VAC	0.95	1.8kg	6KV	280	172.7
LSZD-200W-DL/SEN (With Microwave sensor)	200W 150W 100W	LITEON [®] SMD5050	40000lm 30000lm 20000lm	5000K	70	110°	90~305VAC	0.95	1.8kg	6KV	280	172.7

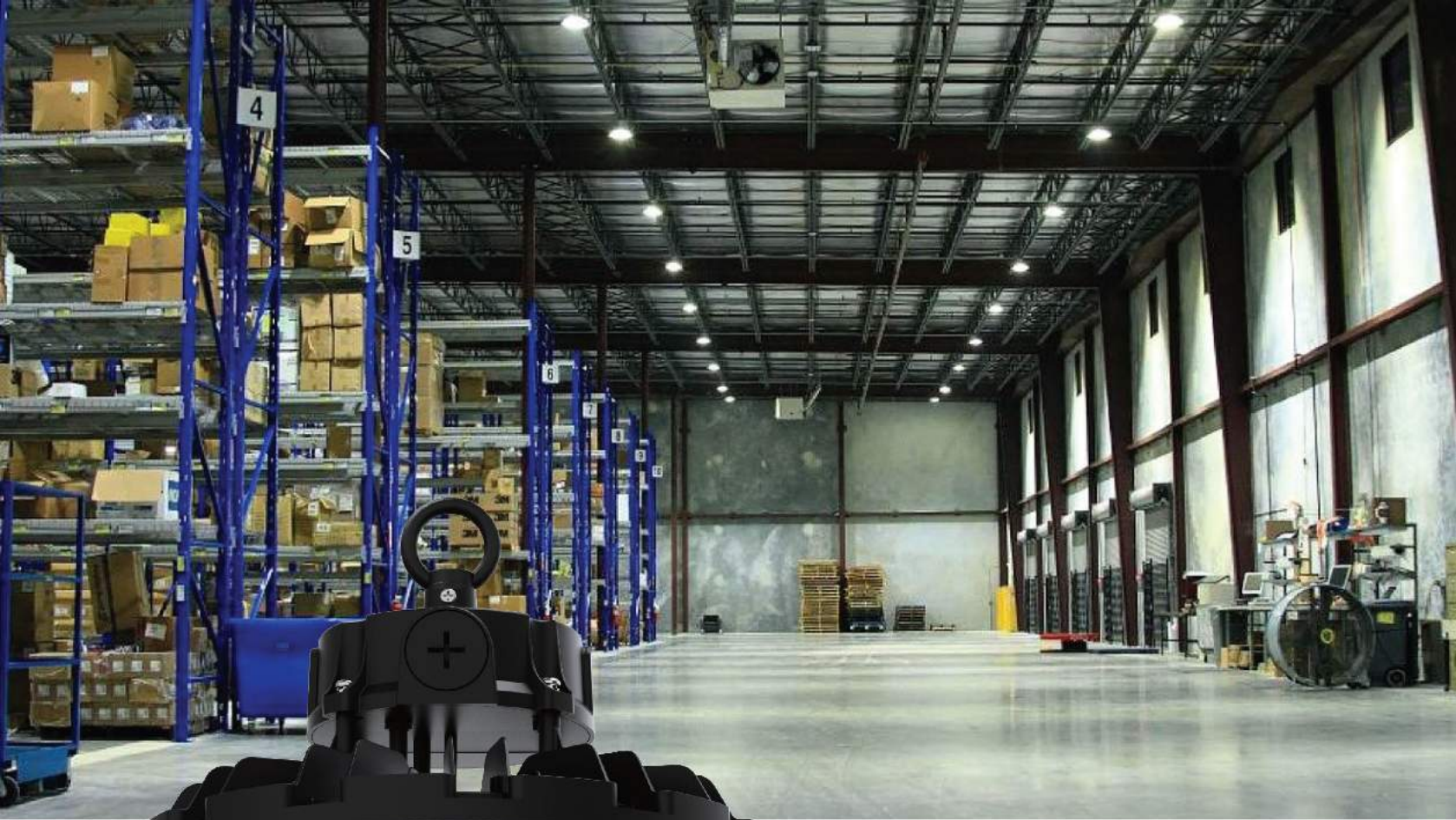

Beam Angle Adjustable

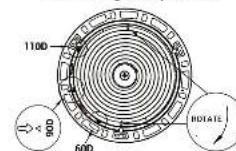

HIGH BAY
Motion Sensor Compatible

TITAN 9in1

FEATURES AND BENEFITS

- Cutting-edge innovation: Slimmer, Lighter and Brighter Design.
- SMD2835 LEDs with life span 108,000hrs@L70B50.
- SuperLUX up to 160lm/w.
- Driver with 90~305Vac, PF≥0.95, 6kV surge protection.
- SCP/OVP/OTP protection.
- 3-in-1 Power selectable and colour temp by dip-switch.
- Less SKU and lower shipping cost.
- Adjustable 3 Beam angle 110°/90°/60° on the PC lens.
- Improved anti-glare design of Dot lens with UGR≤22@60°/90°.
- IP65+IK08 protection.
- Pre-wired with regular power plug. 1.8m lead, and mounting hook.
- TGIC tough coating application.
- Available with Surface Mounted installation, default with Ring.
- Available with reflector.
- Complied by IEC60598/CE/RoHS/SAA.
- Rated life span 50,000hrs@L70B50@25°C.
- 5-year warranty "RIP" Recall Insurance Policy.

INSTALLATION

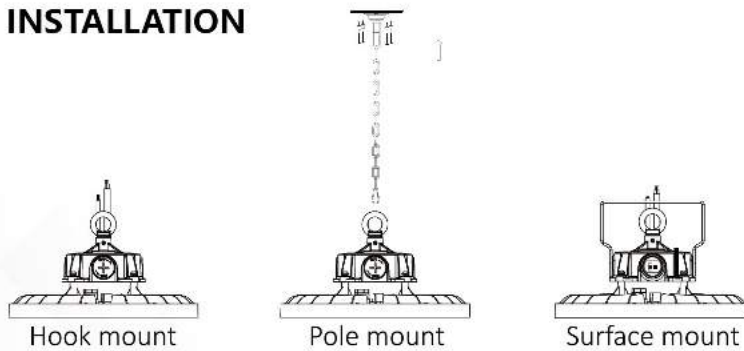

LIGHTWEIGHT INTEGRATION

Equipped with power protection functions including Short Circuit Protection(SCP), Over Voltage Protection(OVP), and Over Temperature Protection(OTP).

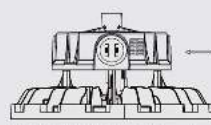

CCT&POWER Selectable version

CCT
WW : 3000K
NW : 4000K
CW : 5000K

Power
120W - 150W - 200W

CUSTOMIZABLE CCT AND WATTANG

Equipped with an adjustable CCT option and controllable power, you can flexibly choose the colour temperature: 3000K, 4000K, 5000K; Fine-tune the brightness level: adjust the power from 120W to 150W, or even 200W. Its lumen output is 160LM/W(RBC).

Power switch



CCT Switch

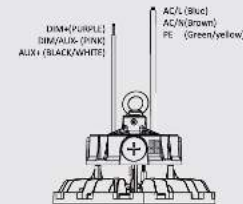

VARIOUS CONTROL OPTIONS

Dimming control options include a single-lamp microwave sensor or group microwave constant illumination controller (0-10V/PWM, auxiliary power supply 200MA 12V)

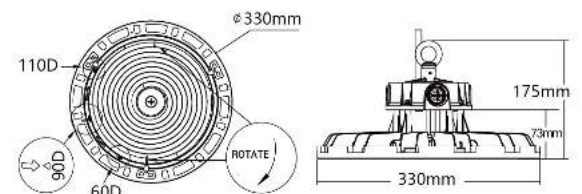

MODEL	Power Selectable	LEDs	LUMENS	CCT	CRI	Beam Angle	Voltage	PF	N.W./pc	Surge Protection	Dimension D	Dimension H
LSTD-200WPS-CCT	200W 150W 120W	 LUMILEDS SMD2835	32000lm 24000lm 19200lm	5000K 4000K 3000K	80	110° 90° 60°	90~305VAC	0.95	2.43kg	6KV	330	175

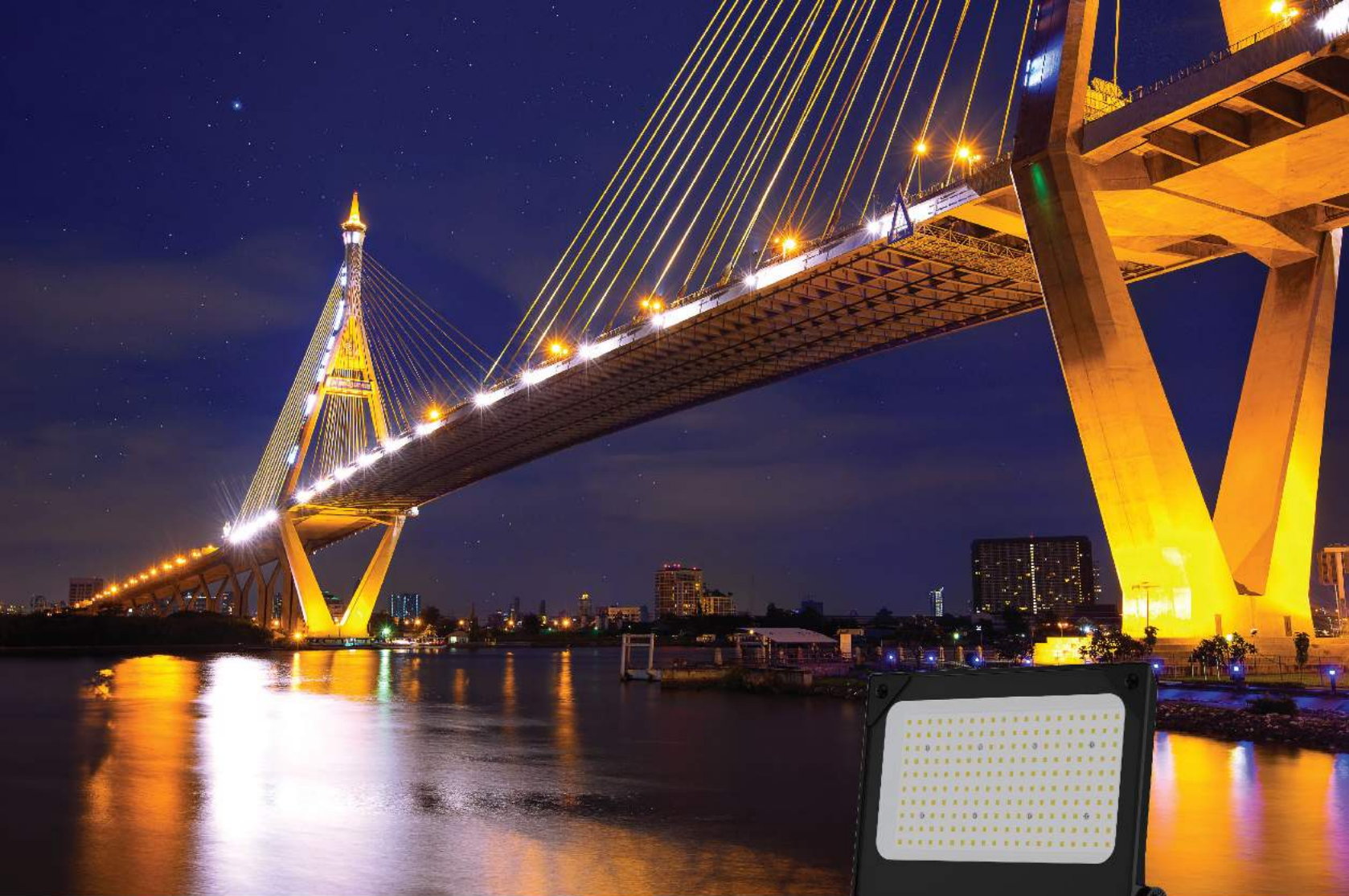

LUMILEDS SMD2835	170 lm/w	CRI 70	120° Beam Angle	LM80	TM21
Operating temp -20°C-50°C	90-305Vac	SOSEN Driver	6KV surge protection		
TGIC painting	IP66	IK08			
IES available	50,000 hrs	5 Year Warranty	CE	RoHS	



FLOODLIGHT
MARS

FEATURES AND BENEFITS

- CCT & Power selectable.
- Day light sensor only applied to 100W/200W/300W models.
- Cutting-edge innovation: Slimmer, Lighter and Brighter Design.
- SMD2835 LEDs with high-lumen output. Rated 170lm/w and up to 180lm/w.
- Built-in Driver provides 90-305Vac, 6/6kV surge, and high
- Efficiency of up to 96%.
- Pre-wired with regular power plug, 1.2m lead.
- TGIC tough coating application.
- IP66 and IK08 impact resistant.
- Rated life span 50,000hrs.
- 5-year warranty. "RIP" Recall Insurance Policy.



INSTALLATION



1
Fix the floodlight onto the mounting surface with 2pcs M10 screws and relevant washers.

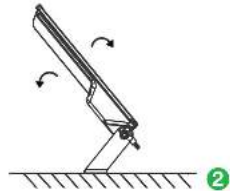

2
Adjust the direction of floodlight by unscrew the side hexagon socket head screws.

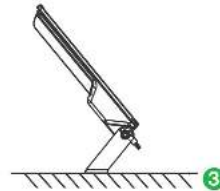

3
After adjust the direction, fasten the unscrewed screws and complete wiring properly.



4
DIM +(PURPLE)
DIM/AUX-(PINK)
AUX +(BLACK/WHITE)
AC/L(BROWN)
AC/N(BLUE)
PE(GREEN/YELLOW)

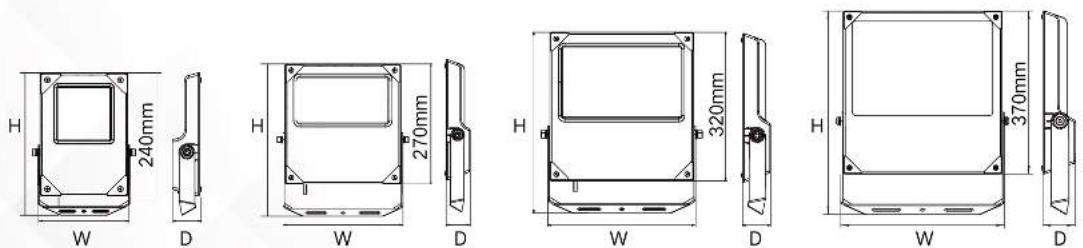

MODEL	Power Selectable	LEDs	LUMENS	CCT	CRI	Beam Angle	Voltage	PF	N.W./pc	Surge Protection	Dimension		
											W	H	D
LLFM-50WPS-CCT	50W 30W 20W	LUMILEDS SMD2835	8500lm 5100lm 3400lm	3000K 4500K 6500K	70	120°	90~305VAC	0.95	1.71kg	6KV	170	277	56
LLFM-100WPS-CCT	100W 80W 50W	LUMILEDS SMD2835	17000lm 13600lm 8500lm	3000K 4500K 6500K	70	120°	90~305VAC	0.95	2.84kg	6KV	270	342	54
LLFM-200WPS-CCT	200W 150W 120W	LUMILEDS SMD2835	34000lm 25500lm 20400lm	3000K 4500K 6500K	70	120°	90~305VAC	0.95	4.21kg	6KV	3192	390	60

Lightweight Design Robust Lighting



Prices are subject to change without prior notice



Flood Light

FEATURES

- SMD LED technology, ≥ 90 lumens/watt.
- Efficient and robust LED driver technology.
- Heavy duty aluminum casing.
- Weatherproof IP65 rating and With surge protection.
- Heavy duty steel yoke with stainless steel screws, for post top, surface or wall mounting options.
- Impact resistant, tempered glass cover.
- Cool operation, noiseless and maintenance less.
- Environment friendly, no IR & UV, non hazardous, CE & RoHS compliant, performance & safety operation conforms to international standards.



LED Lite Flood Light - 20W

MODEL	CCT	LUMENS	CRI
LLFL-20WDL	5000K	1800lm	>70

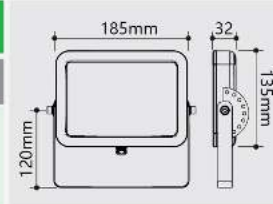

LED Lite Flood Light - 30W

MODEL	CCT	LUMENS	CRI
LLFL-30WDL	5000K	2700lm	>70

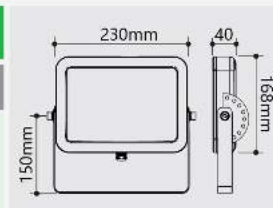

 240V	 25,000 Hours	 UP TO 85% ENERGY SAVINGS
 Non-Dimmable	 Beam Angle 110°	 IP Rating IP65
 Flex & Plug	 RoHS Compliant	 CE
 NO UV/IR	 FC	 SAFE EASY TO USE
		

PACKING:
20W 10pcs/ctn
30W 10pcs/ctn

Make the switch to Omni LED Weatherproof square floodlights for effective outdoor illumination

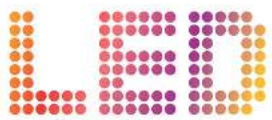

Flood Light

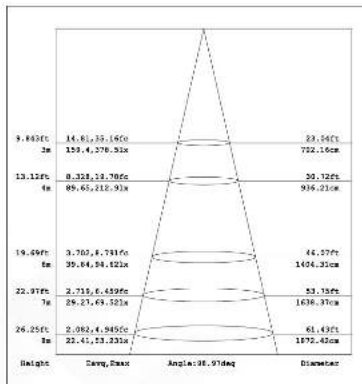
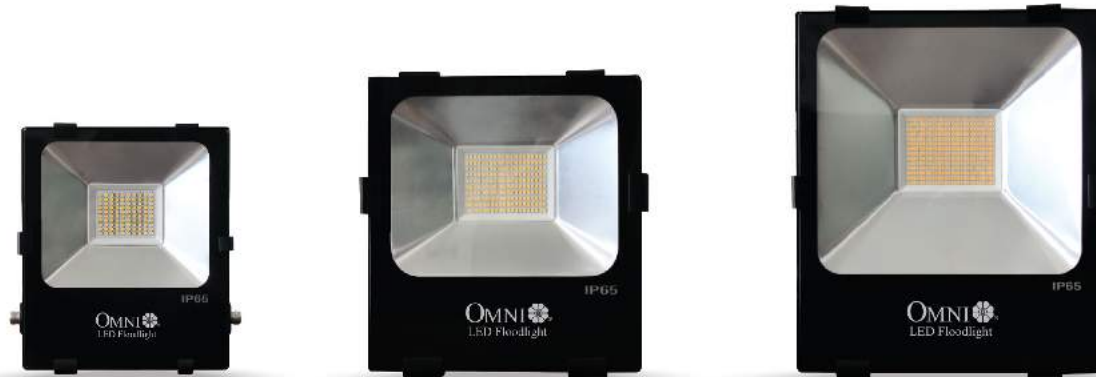



▲ 150W

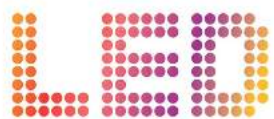

Multi Functional Floodlight



◀ LTL-150W



◀ LMFL-300W

FEATURES

- LED retrofit for traditional HID/HPS, more energy- saving solution.
- High-pure aluminum housing with FIN design in IP65, good for heat-sink.
- High luminous efficiency, up to 100lm/W.
- NO UV/IR, eco-friendly.
- Long life span, up to 40,000hrs.
- SAA/CE/RoHS passed.
- Suitable for using in petrol station, tunnel etc.

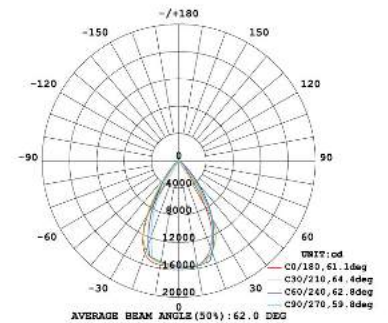

INSTALLATION

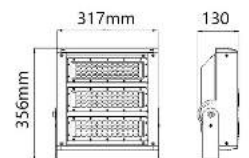
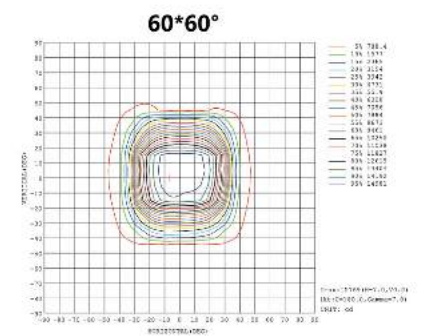
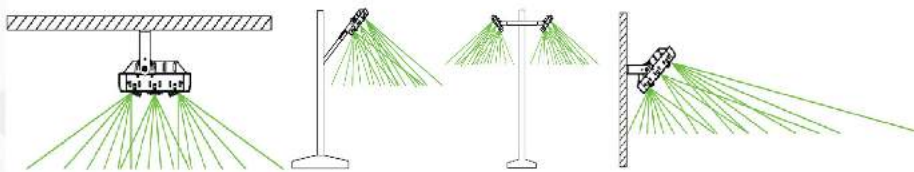

MODEL	WATT	CCT	LUMENS	VOLTAGE	CRI	PF	BEAM ANGLE	PACKING
LTL-150W-DL	150W	6500K	13500lm	240V	>80	>0.9	60°*60°	1pcs/ctn
LMFL-300W-DL	300W	6500K	39000lm	240V	>80	>0.9	80°*150°	1pcs/ctn